

Full HD Indoor Dome Network Camera

Panasonic WV-U2130L captures the highest quality images in even very challenging and dynamic environments. Intelligent Auto (iA) monitors scene dynamics and motion to adjust key camera settings automatically in real-time reducing distortion such as motion blur on moving objects. By adopting H.265 Smart Coding technology, bandwidth efficiency is intelligently increased for longer recording and less storage.

Extreme image quality allows evidence to be captured even under challenging conditions

- Auto Shutter speed control for fast moving objects
- Sharp and clear images of a walking person day & night
- Outstanding low light performance in true color with low noise for night time applications
- Super Dynamic 120dB for backlit situations involving headlights and shadows on night streets

Extreme bandwidth compression with Panasonic H.265 Smart Coding

- Longer recording and less storage compared to any H.264 based compression techniques
- Self-learning ROI* encoding (Auto VIQS) detects movement within the image and compresses the areas with little motion in order to reduce transmitted data while maintaining the quality of the image.

*Region of Interest

Key Features

- Full HD 1080p up to 30fps
- iA (intelligent Auto)
- Super Dynamic 120dB
- Color night vision (0.006 to 0.1 lx)
- H.265 Smart Coding
- Corridor mode
(90 degrees or 270 degrees in image rotation)
- Onvif Profile G / T

Industry examples

- Retail
- Education
- Public safety
- Bank / Hospital / Building



Specifications

Camera	Image Sensor	Approx. 1/3 type CMOS image sensor
	Minimum Illumination	Color : 0.1 lx, BW : 0.04 lx (50IRE, F2.0, Maximum shutter : Off (1/30s), AGC : 11) BW : 0 lx (50IRE, F2.0, Maximum shutter : Off (1/30 s), AGC : 11, when the IR LED is lit) Color : 0.006 lx, BW : 0.0025 lx (50IRE, F2.0, Maximum shutter : max. 16/30s, AGC : 11) *1
	White Balance	ATW1 / ATW2 / AWC
	Maximum shutter	[30fps mode] Max. 1/10000 s to Max. 16/30 s [25fps mode] Max. 1/10000 s to Max. 16/25 s
	Intelligent Auto	On / Off
	Super Dynamic	On / Off, The level can be set in the range of 0 to 31.
	Dynamic Range	Max. 120 dB (Super Dynamic : On, Level: 31)
	Adaptive Black Stretch	The level can be set in the range of 0 to 255.
	Back light compensation / High light compensation	BLC (Back light compensation) / HLC (High light compensation) / Off The level can be set in the range of 0 to 31. (only when Super dynamic / Intelligent Auto : Off)
	Fog compensation	On / Off, The level can be set in the range of 0 to 8. (only when Intelligent auto / auto contrast adjust: Off)
	Maximum gain (AGC)	The level can be set in the range of 0 to 11.
	Color/BW (ICR)	Off / On (IR Light Off) / On (IR Light On) / Auto1 (IR Light Off) / Auto2 (IR Light On) / Auto3 (SCC)
	IR LED Light	High / Middle / Low / Off, Maximum irradiation distance : 30 m (Approx. 100 ft)
	Digital Noise Reduction	The level can be set in the range of 0 to 255.
	Video Motion Detection (VMD)	On / Off, 4 areas available
	Scene Change Detection (SCD)	On / Off, 1 area available
	Privacy Zone	On / Off, Up to 8 zones available
	VIQS	On / Off, Up to 8 zones available
	Image rotation*2	0° (Off) / 90° / 180° (Upside-down) / 270°
	Camera Title (OSD)	On / Off, Up to 20 characters (alphanumeric characters, marks)
Lens	Focal length	3.2 mm(1/8 inches)
	Optical zoom	1x
	Extra zoom	1.0x - 1.5x(when resolution is 1280x720)
	Digital (electronic) zoom	Choose from 3 levels of x1, x2, x4
	Angular Field of View	[16 : 9 mode] Horizontal : 100° Vertical : 54° [4 : 3 mode] Horizontal : 81° Vertical : 60°
	Maximum Aperture Ratio	1 : 2.0
Focusing Range	1 m (39-3/8 inches) - ∞	
Adjusting Angle		Horizontal (PAN) angle: -175° ~ +175°, Vertical (TILT) angle: -30° ~ +80° Azimuth (YAW) angle: ±100°
Browser GUI	Camera Control	Brightness
	GUI / Setup Menu Language	English, Italian, French, German, Spanish, Portuguese, Russian, Chinese, Japanese
Network	Network IF	10Base-T / 100Base-TX, RJ45 connector
	Resolution	[16 : 9 mode] 1920x1080, 1280x720, 640x360, 320x180 [4 : 3 mode] 1600x1200, 1280x960, VGA, QVGA
	H.265	Transmission Mode Constant bit rate / VBR / Frame rate / Best effort
	H.265	Transmission Type Unicast port(AUTO) / Unicast port(MANUAL) / Multicast
	JPEG	Image Quality 10 steps

Network	Smart Coding	GOP(Group of pictures) control: On(Frame rate control)/ On(Advanced)/ On(Mid.)/ On(Low)/ Off AUTO VIQS: On/ Off	
	Audio Compression	—	
	Audio transmission mode	—	
	Supported Protocol	IPv6 : TCP/IP, UDP/IP, HTTP, HTTPS, SMTP, DNS, NTP, SNMP, DHCPv6, RTP, MLD, ICMP, ARP, IEEE 802.1X, DiffServ IPv4 : TCP/IP, UDP/IP, HTTP, HTTPS, RTSP, RTP, RTP/RTCP, SMTP, DHCP, DNS, DDNS, NTP, SNMP, UPnP, IGMP, ICMP, ARP, IEEE 802.1X, DiffServ	
	No. of Simultaneous Users	Up to 14 users (Depends on network conditions)	
	SDXC/SDHC/SD Memory Card (Option)	H.265 recording: Manual REC / Alarm REC (Pre/Post) / Schedule REC / Backup upon network failure Compatible microSDXC/microSDHC Memory Card: microSD speed class6 or higher Panasonic 32 GB*, 64 GB**model *microSDHC card, **microSDXC card	
	Mobile Terminal Compatibility	iPad, iPhone, Android™ terminals	
	ONVIF Profile	G / T	
	Alarm	Alarm Source	VMD alarm, SCD alarm, Command alarm
		Alarm Actions	SDXC/SDHC/SD memory recording, E-mail notification, HTTP alarm notification, Indication on browser, Panasonic alarm protocol output
Input/ Output	Monitor Output (for adjustment)	—	
	Audio input	—	
	Audio Output	—	
	External I/O Terminals	—	
General	Safety	UL (UL60950-1), c-UL (CSA C22.2 No.60950-1), CE, IEC60950-1	
	EMC	FCC (Part15 ClassA), ICES003 ClassA, EN55032 ClassB, EN55024	
	Power Source and Power Consumption	PoE (IEEE802.3af compliant) Device : DC48 V 100 mA, Approx. 4.8 W (Class 2 device)	
	Ambient Operating Temperature	-10 °C to +50 °C (+14 °F to +122 °F) {Power On range: 0 °C to +50 °C (+32°F to +122 °F)}	
	Ambient Operating Humidity	10 to 90 % (no condensation)	
	Dimensions	ø109 mm x 62 mm (H) (ø4-9/32 inches x 2-7/16 inches (H)) Dome radius 30.5 mm (1-3/16 inches)	
	Mass (approx.)	250 g (0.55 lbs)	
	Finish	Main body : Aluminum die cast / Polycarbonate resin, i-PRO white Dome section : Polycarbonate resin, Clear	





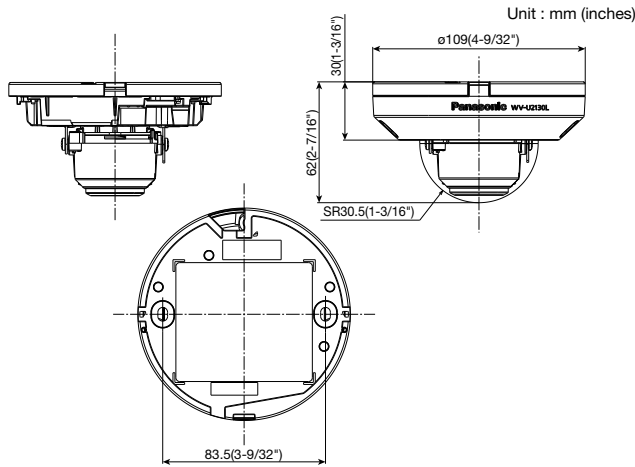

*1 Converted value
*2 When "4:3(30fps mode)" or "4:3(25fps mode)" is selected for "Image capture mode", "90 °" and "270 °" cannot be selected.

Appearance



Trademarks and registered trademarks
 – iPad and iPhone are trademarks of Apple Inc., registered in the U.S. and other countries.
 – Android is a trademark of Google LLC.
 – ONVIF is trademarks or registered trademarks of Onvif Inc.
 – All other trademarks identified herein are the property of their respective owners.

Optional Accessories

Mount Bracket / Dome Cover / Other		
Ceiling Mount Bracket WV-QCL101-W (i-PRO white)  *For indoor installation only	Wall Mount Bracket WV-QWL500-W (i-PRO white) 	Adapter Box WV-QJB500-W (i-PRO white)  (This bracket requires WV-QWL500-W.)
Pole Mount Bracket WV-QPL500-W (i-PRO white) 	Corner Mount Bracket WV-QCN500-W (i-PRO white) 	Dome Cover (Smoke type) WV-QDC500S 

• Brackets are available in four colors, Fine silver, Light gray, Gray and i-PRO white. It is possible to use them in different color combinations.

Important
 – Safety Precaution : Carefully read the Basic Information, Installation Guide and Operating Instructions before using this product.
 – Panasonic cannot be responsible for the performance of the network and/or other manufacturers' products used on the network.

• Masses and dimensions are approximate. • Specifications are subject to change without notice.

Panasonic[®]
 Panasonic Corporation

Panasonic i-PRO Sensing Solutions Co., Ltd.

<https://ipro.panasonic.com>
<https://security.panasonic.com>

<https://www.linkedin.com/company/i-pro-sensing-solutions-co-ltd/>